

KENIA SERIES







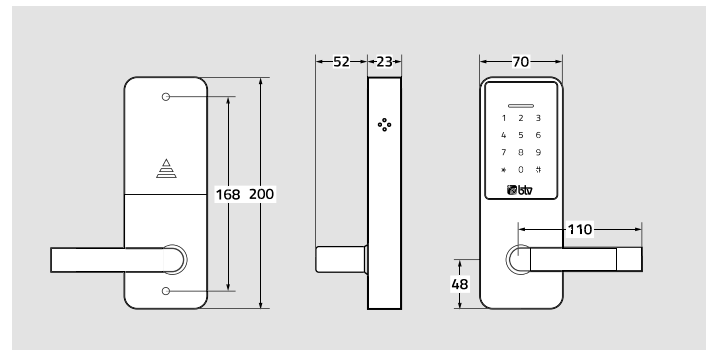

Electronic lock for apartments or rooms for rent.

Makes access easier for the guest and hotel staff, physical key is not required.

Features

- Electronic lock with **solid body made of zinc alloy with anticorrosion treatment.**
- **Anti-tamper handle with free rotation**, prevents forcing an opening by levering.
- **Emergency mechanical lock** located at the bottom of the housing.
- **Micro-USB** port supply connection in case of low battery, located at the base of the housing.
- **Backlit touch keypad.**
- **Handle** for doors with **left or right opening available.**
- **PCB sealed** with silicon encapsulated treatment for high humidity environments.
- **Remote management by Smartphone and/or tablet** through the **iLockey app** available for **iOS & Android.**
- **Lock adaptable to any door** with a square bar.
- For **doors of thickness** between **28-110 mm.**



	<i>Managed via app</i>		<i>Password</i>		<i>User management</i>
	<i>Suitable for outdoors</i>		<i>3 emergency keys</i>		<i>Auto lock</i>
	<i>Low battery alert</i>		<i>Free handle</i>		<i>4 AA batteries</i>



Lock

Lock adaptable to any door with a square bar.
Simple anti-friction latch.

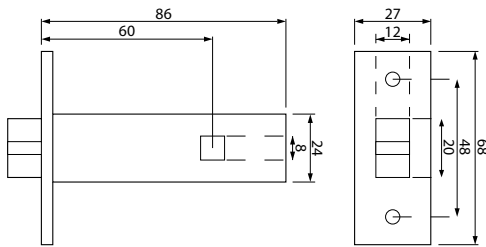

Compatible with automatic anti-panic security locks

iLockey app

Creates, sends and manages the electronic keys and numeric keycodes without having to be near the lock to do so. Access opening record, check battery charge status and assign permanent, access codes via Bluetooth.

The different opening codes can be useful for a certain period time (single use, periodic or cyclical) or indefinitely.

Opening modes

- **Electronic key:** the lock administrator sends the electronic key to the guest through the app and the guest opens it via the app using Bluetooth.
- **Numeric keycode:** sent by text message, email or Whatsapp, for example, entered on the lock keypad.
- Emergency **mechanical lock.**

